**NX17-XL**

Needle roller/axial ball bearing

Schaeffler ID:
0507785870000Needle roller/axial ball bearings NX,
single direction axial component, for oil
lubrication

X-life

Technical information

2)

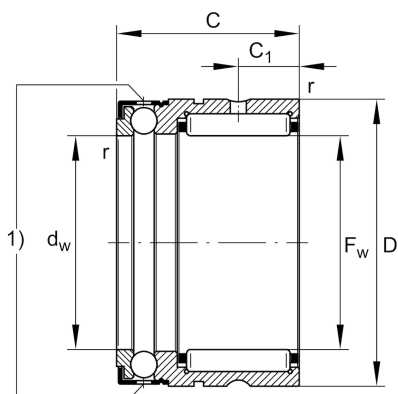
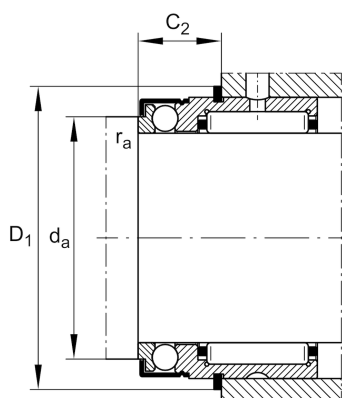
**Main Dimensions & Performance Data**

F_w	17 mm	Bore diameter
D	26 mm	Outside diameter
C	28 mm	Height
C_r	13,500 N	Basic dynamic load rating, radial
C_{0r}	15,000 N	Basic static load rating, radial
C_a	5,800 N	Basic dynamic load rating, axial
C_{0a}	11,500 N	Basic static load rating, axial
C_{ur}	2,800 N	Fatigue load limit, radial
C_{ua}	530 N	Fatigue load limit, axial
n_G	7,500 1/min	Limiting speed
	50.61 g	Weight

Dimensions

	IR14X17X17-XL	Suitable inner rings IR
	WR26, SW26	Snap ring
C_1	8 mm	Distance to lubrication hole
C_2	8 mm	Distance to lubrication hole
d_w	17 mm	Bore diameter of shaft washer
r_{min}	0.3 mm	Minimum chamfer dimension

Mounting dimensions

d_a	21 mm	Mounting dimension shaft shoulder
$r_{a max}$	0.3 mm	Maximum recess radius
D_1	28.5 mm	Connection diameter snap ring
C_2	12.2 mm	Connection width with snap ring

Temperature range

T_{min}	-30 °C	Operating temperature min.
T_{max}	120 °C	Operating temperature max.